Easywall Reinforced Mineral Composite Panel



A brand name of Easywall Holding F.Z.E

EASY WALL

www.easy-wall.ir

We tried hard to make a special product with our technical local knowledge, raw materials and designed machinery inside the country. This special product adapted to Iran earth quick stricken and distributed to young and active Iran society.

Armed Easy wall composite Super panel is a unique production away from all shortages come from raw materials and foreign machineries, that lowered our construction industry qualification due to political limitation. Easy wall panels presented to the great society of construction industry engineers and the demanders so that we can assist you to enhance construction assurance against natural events and ease the way of house providing in the youngest country of the world.

Composite is the combination of raw material which is correctly combined partially. Therefore the result of the combination has kept the nature of materials and covered the weak points so produced a strong and improved materials.

In easy wall composite combination, more than 7 minerals powder and resin materials that partially combined with special fibers manufactured final production with high strength against fire and moisture that can bear high pressure with better flexibility.

EASY WALL models

E9

Used: Inside Wall
Width: 46 cm
Thickness: 9 cm
Height: 360 cm max(in one piece)
Weight: 36 kg (square meter)

E12

Used: External Wall
Width: 46 cm
Thickness: 12 cm
Height: 360 cm max(in one piece)
Weight: 38 kg (square meter)

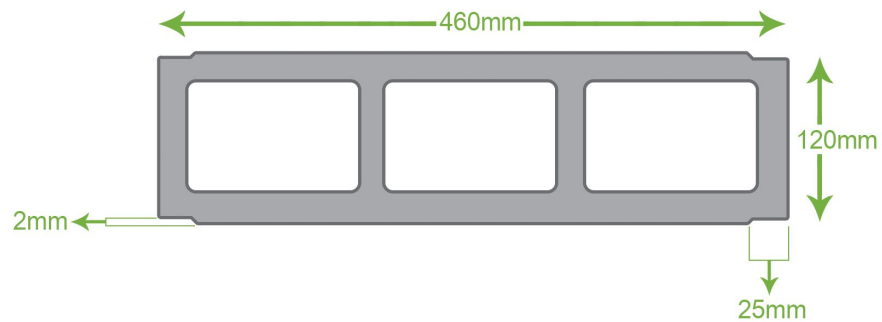

- Get a New Technology Confirmation from:
 - Ministry of Industries and Mines
 - Vice Presidency of Science and Technology
 - Tehran University of Science and Technology Park
- Get a Implementing an integrated management system Confirmation from AMERICAN GLOBAL STANDARD
- Get a Confirmation from Iran Building and Housing Research Center
- The first rank of the Alborz National Elite Foundation Inventions
- Get a Free Asbestos Confirmation from TEHRAN UNIVERSITY OF MEDICAL SCIENCES
- The second rank of the Dr. Chamran Scientific Festival at Tehran University
- Get a Confirmation from IRANIAN SCIENTIFIC AND RESEARCH ORGANIZATION
- The third rank of Quality Management from AMERICAN GLOBAL STANDARD
- The third rank of Italian Design World Championships A'Design
- Attend the MOOD (Museum of Design) in 2013
- And more ...



ISO 9001:2008



ISO 14001:2004



ISO 18001:2007



4 Benefits

Evaluating and comparing Easy wall to other local and international products in terms of, unique specifications and privileges, made it as a special product in construction industry.

Registration of more than 3 inventions locally and finalization of international registration of the product by world registration invention organization and at the same time presenting ISI articles and participating in world competitions easy wall will be the nomination of the best scientific and technical award internationally.



The Safest Wall

Easy wall reinforced with plastic mesh netting. This feature creates integrity at a glance and level raw material. This is very important because it increases the safety of earthquakes, storms and fires.

Reasons to reinforce the Easy wall

- Double increase of pressure ductility
- 3 Supercharge energy absorption at pressure
- 40 times more elasticity in stretching
- Increase 80-fold energy absorption in stretching



The Lightest Wall

Building materials are divided into four groups in terms of weight. Easy wall is in the very light category because of its very low weight.

Only 36 kg (square meter)



The Fastest Wall

We will have the fastest and easiest installation, because this wall is a custom height, panel mode and very light. We will install more than 100 meters in one shift job only with a 5-person team



The Best Price

If calculate in structural calculations product weight it will be Free Wall for Builders

4 Benefits

+16 Benefits



Safe as the filler wall between the frames



Match to Professor Hugo Bachmann Calculations



Easy and Fast Installation



Mechanical and Electrical Installations without destruction

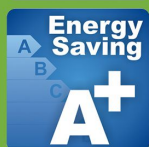

Safe for Interior Decoration



NO Waste



Best Energy Saver

Resistant to fire for 2 hours



Resistant Humidity



Free Asbestos (NIOSH 9002)z

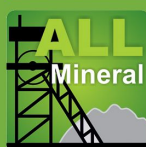

All Mineral and without any chemical additives



Eco-friendly and Recyclable



Designed for All Seasons Climate



Technical, Material and Machinery are Made in IRAN



Easy Wall made for Best Building



Easy Wall for Now and Future

Gypsum Plaster **1**

Cement Plaster **2**

Sticking Rocks **3**

Sticking Tile **4**

Sticking Tile With glue **5**

Alcobond **6**

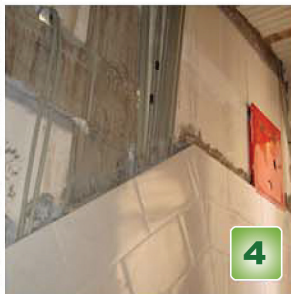

You can do easily all finishing on Easy Wall and this is all confirmed by the engineering system
We always tride to be consistant with all the building materials. To be consistent with traditional building materials, Industrial and New materials



INSTALLATION

The name of pre-made wall has been taken from its easy performance . The easy wall is the same pre_made panel easy wall in which the cement and sand have been omitted and instead a special glue has been used and also the blocks turn into panels and large smooth parts .As the result , the performance has been highly speeden up for construction . And also the simple installation has created high security and carefulness for the construction

So that with a 5 people team you can averagely make 100 square . meters easy wall during a daily work

Furthermore due to the product special geometry , the force beard by the easy wall panel against the metal and cement construction superficially cause no great concentrated force over two ends of the columns . As the result transaction with construction system no damage will be imposed over the construction system so this is a very important issue causes the building maintenance and residents survival during the earth quick strikes

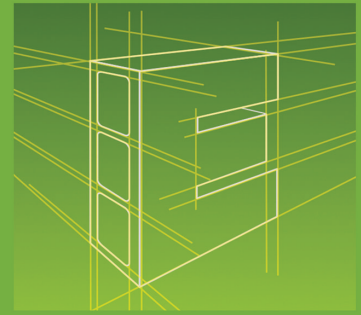

- In Line **1**
- Perpendicular **2**
- Next to the column **3**
- Free **4**
- Diagonal **5**
- Arch **6**
- Retaining wall **7**
- Protective wall **8**
- Site **9**

Results of Easy Wall Tests

20 Kg/cm²

210 Kg/m²

4 Kg/cm²

6 Kg/cm²

Easy wall panels successfully passed more than 300 technical tests in the company laboratory and also passed more than 70 tests in housing and construction research center, located in Tehran university, and mechanic college of Sharif university. Therefore today, Easy wall calculation booklet has been printed as a valid document to prove the capability of the product confirmed by great university teachers and executors. So the booklets will be available to construction engineering.



- 1 Pressure Test
- 2 Tensile Test
- 3 Straight Tensile Test
- 4 Cutting Test Resin
- 5 Bending Test
- 6 sample Pressure Test
- 7 Total Bending Test
- 8 Connection States

INTERIOR DESIGN



You can install very simple and safe all kinds of decoration and LED on Easy Wall

Easy Wall reinforced to plastic mesh net and sticky fibrs. For this reason holds the nail or screw without problem in a long time



COMPARISONS

It is very important to choose the best wall for every construction project. Should be compared, all Building Materials Manufacturers in terms of installation speed, product weights and required plasters. Most Engineers, choose products to successful on average. So with budget constraints, raise the quality of the structure, lower the wight of the structure and project will finish soon as possible.

Sofal	Brick	Gypsum Block	Hebelex Block	Civilica	3DPanel	Easy Wall	
70	28	4/2	9	17/5	1	1	Equivalent pcs
10	3	35	25	30	50	80	Installation speed (square meter)
450	174	88	171	173	116	36	The final weight (kg/m ²)
Yes	Yes	No	Yes	Yes	No	No	Need to plaster soil
Yes	Yes	Yes	Yes	Yes	Yes	No	Need to be chromed
%10	%10	%5	%5	%7	%5	%3	Waste
No	No	No	No	Yes	%5	%15	Light Styling
a lot	a lot	a lot	a lot	a lot	a lot	little	Size of wet work
0/02	0/05	0/33	0/15	0/08	2	1/5	Size of one pcs

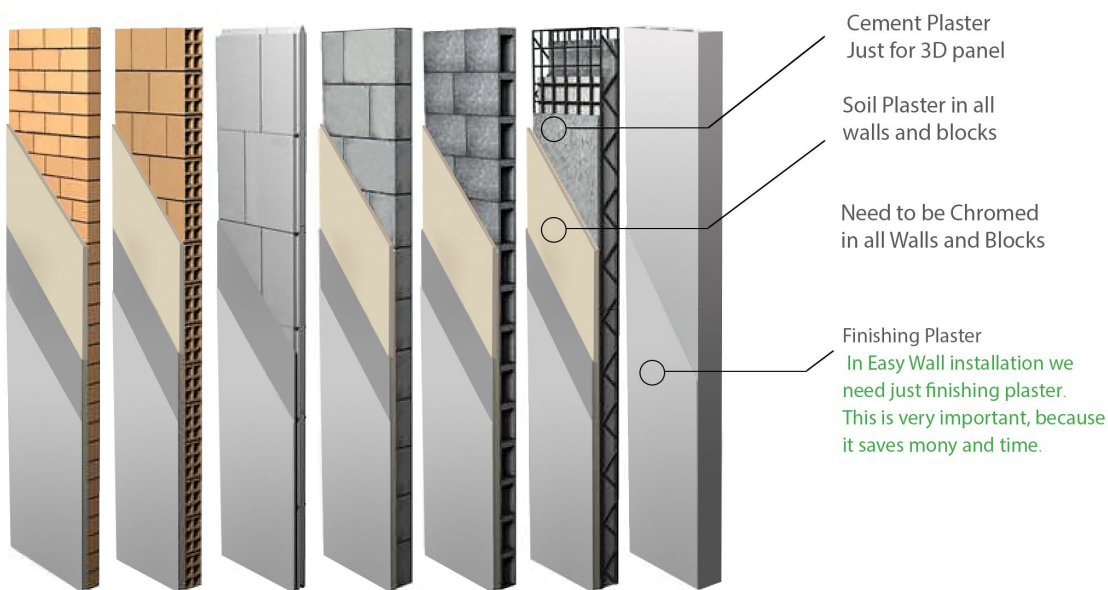

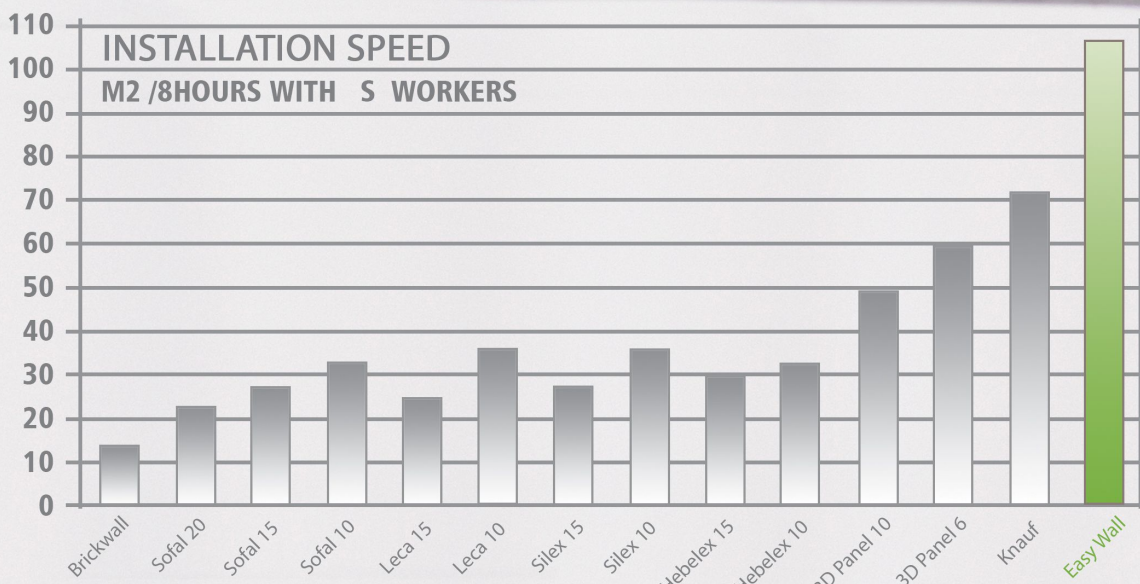

KG/M²

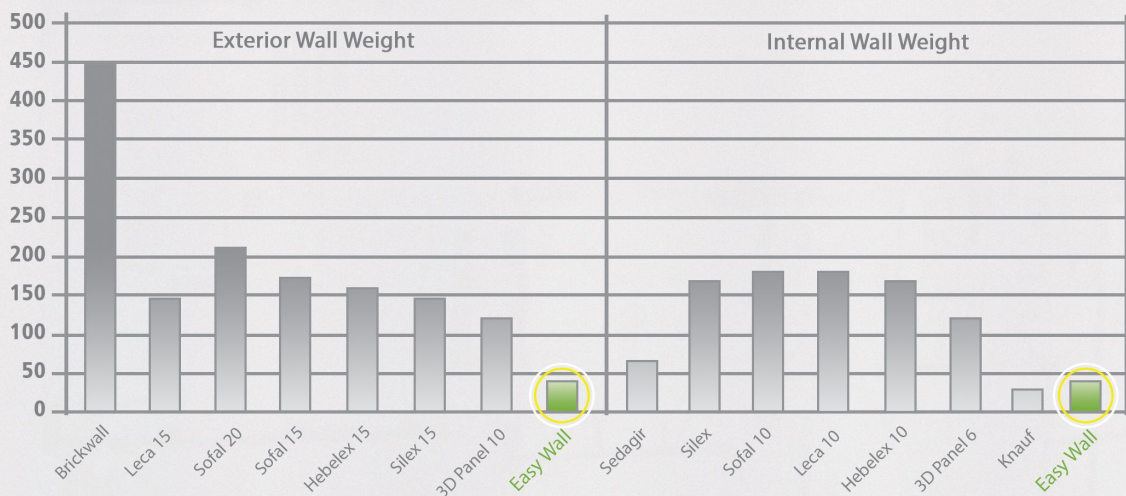

EASY WALL

 **qualityaustria**
SYSTEM CERTIFIED

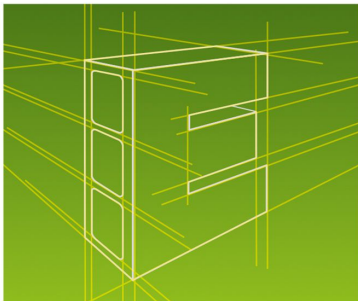

www.brasis.ir
Banaye Rasis 
Knowledgebase Cooperative Company
Reinforced Mineral Composite Panel

Factory address: No.64, 8Alley, Eshgh Abad
Industrial Park, Varamin Road, Tehran-Iran
Tel: +98 21 36695352 - Fax: +98 21 36695342
Mobile: +98 912 285 6127
www.easy-wall.ir
www.brasis.ir
Info@easy-wall.ir